

MITSUBISHI L300

WORKSHOP MANUAL

FILING INSTRUCTION

Please keep these manual pages in the binder which is keeping the manual Pub. No. PWWE8608.

File these pages according to the signs "ADDED", "REVISED" and "DELETED" on the "List of Effective Pages" which are interpreted below.

ADDED: File the pages with this sign additionally in your manual.

REVISED·DELETED: Replace the existing pages with the corresponding pages with this sign.

Missing sheets will be supplied upon request.

LIST OF EFFECTIVE PAGES

Group/ Page	Revision code	Date	Remarks	Group/ Page	Revision code	Date	Remarks
List of Effective Pages				19-25 thru 19-26	N	July 1993	
1 thru 10	O	Jun. 1994	REVISED	19-27 thru 19-32	O	Jun. 1994	ADDED
11 thru 13	O	Jun. 1994	ADDED	20	D	July 1988	
Foreword				21		Nov. 1986	
1	O	Jun. 1994	REVISED	22	B	July 1987	
How to Use This Manual				23		Nov. 1986	
1	O	Jun. 1994	REVISED	23-1	H	Jun. 1990	
2	B	July 1987		23-2	B	July 1987	
01 - General				23-3	H	Jun. 1990	
1	K	Nov. 1991		23-4	B	July 1987	
2	O	Jun. 1994	REVISED	23-5	H	Jun. 1990	
3	I	Nov. 1990		23-6	D	July, 1988	
3-1	O	Jun. 1994	REVISED	23-7 thru 23-8	H	Jun. 1990	
3-2	K	Nov. 1991		23-9 thru 23-10	J	July 1991	
4	K	Nov. 1991		23-11 thru 23-12	K	Nov. 1991	
4-1 thru 4-2	O	Jun. 1994	REVISED	23-13 thru 23-16	O	Jun. 1994	ADDED
5	O	Jun. 1994	REVISED	24	C	Nov. 1987	
6		Nov. 1986		25		Nov. 1986	
7	O	Jun. 1994	REVISED	25-1	F	July 1989	
7-1	O	Jun. 1994	REVISED	25-2	B	July 1987	
7-2	K	Nov. 1991		25-3	H	Jun. 1990	
8 thru 9	K	Nov. 1991		25-4	D	July 1988	
10 thru 11	B	July 1987		25-5 thru 25-6	F	July 1989	
12 thru 13		Nov. 1986		25-7 thru 25-8	H	Jun. 1990	
14	C	Nov. 1987		25-9 thru 25-10	J	July 1991	
15		Nov. 1986		25-11 thru 25-12	O	Jun. 1994	ADDED
16	C	Nov. 1987		26	C	Nov. 1987	
17		Nov. 1986		27 thru 28		Nov. 1986	
18 thru 19	C	Nov. 1987		29	C	Nov. 1987	
19-1 thru 19-2	E	Dec. 1988		29-1	E	Dec. 1988	
19-3 thru 19-6	C	Nov. 1987		29-1 thru 29-4	C	Nov. 1987	
19-7	K	Nov. 1991		29-5 thru 29-8	E	Dec. 1988	
19-8	G	Nov. 1989		29-9	H	Jun. 1990	
19-9	K	Nov. 1991		29-10	F	July 1989	
19-10	G	Nov. 1989		29-11	H	Jun. 1990	
19-11	K	Nov. 1991		29-12	F	July 1989	
19-12	G	Nov. 1989		29-13	H	Jun. 1990	
19-13	K	Nov. 1991		29-14	F	July 1989	
19-14	G	Nov. 1989		29-15 thru 29-16	H	Jun. 1990	
19-15	K	Nov. 1991		29-17	J	July 1991	
19-16	G	Nov. 1989		29-18 thru 29-24	L	July 1992	
19-17	K	Nov. 1991		29-25 thru 29-26	O	Jun. 1994	ADDED
19-18	G	Nov. 1989		30		Nov. 1986	
19-19 thru 19-20	I	Nov. 1990		31	N	July 1993	
19-21 thru 19-22	K	Nov. 1991		32	E	Dec. 1988	
19-23 thru 19-24	M	Nov. 1992		33 thru 35		Nov. 1986	
				35-1 thru 35-2	K	Nov. 1991	
				36 thru 39		Nov. 1986	
				39-1 thru 39-2	J	July 1989	

LIST OF EFFECTIVE PAGES

Group/ Page	Revision code	Date	Remarks	Group/ Page	Revision code	Date	Remarks
40 thru 42		Nov. 1986		44-2	J	July 1991	
43	F	July 1989		45	O	Jun. 1994	REVISED
44 thru 48		Nov. 1986		46	D	July 1988	
49	F	July 1989		47 thru 50	O	Jun. 1994	REVISED
50	M	Nov. 1992		50-1 thru 50-10	O	Jun. 1994	ADDED
51 thru 52	H	Jun. 1990		51 thru 55	O	Jun. 1994	REVISED
11 - Engine				55-1 thru 55-6	O	Jun. 1994	ADDED
1 thru 3	O	Jun. 1994	REVISED	56 thru 59	O	Jun. 1994	REVISED
3-1 thru 3-2	O	Jun. 1994	ADDED	59-1 thru 59-8	O	Jun. 1994	ADDED
4 thru 5	O	Jun. 1994	REVISED	60		Nov. 1986	
5-1 thru 5-2	O	Jun. 1994	ADDED	61	I	Nov. 1990	
6	O	Jun. 1994	REVISED	62	C	Nov. 1987	
6-1 thru 6-2	O	Jun. 1994	ADDED	62-1 thru 62-2	B	July 1987	
7	O	Jun. 1994	REVISED	63		Nov. 1986	
7-1 thru 7-2	O	Jun. 1994	ADDED	64 thru 71	O	Jun. 1994	REVISED
8 thru 9	O	Jun. 1994	REVISED	71-1 thru 71-6	O	Jun. 1994	ADDED
9-1 thru 9-2	O	Jun. 1994	ADDED	72 thru 75	O	Jun. 1994	REVISED
10	O	Jun. 1994	REVISED	75-1 thru 75-4	O	Jun. 1994	ADDED
11		Nov. 1986		76 thru 79	O	Jun. 1994	REVISED
12	O	Jun. 1994	REVISED	79-1 thru 79-4	O	Jun. 1994	ADDED
12-1	O	Jun. 1994	REVISED	80	L	July 1992	
12-2	L	July 1992		80-1 thru 80-2	L	July 1992	
13	J	July 1991		81 thru 83	O	Jun. 1994	REVISED
14		Nov. 1986		84	J	July 1991	
15 thru 16	N	July 1993		85 thru 88	O	Jun. 1994	REVISED
17		Nov. 1986		89 thru 90		Nov. 1986	
18	O	Jun. 1994	REVISED	91	F	July 1989	
19	J	July 1991		92 thru 93	N	July 1993	
20	H	Jun. 1990		94 thru 100		Nov. 1986	
21 thru 22		Nov. 1986		12 - Lubrication			
23	F	July 1989		1	K	Nov. 1991	
24	K	Nov. 1991		1-1 thru 1-2	K	Nov. 1991	
25	H	Jun. 1990		2		Nov. 1986	
26 thru 29		Nov. 1986		3	M	Nov. 1992	
30	I	Nov. 1990		4		Nov. 1986	
31		Nov. 1986		4-1 thru 4-2	J	July 1991	
31-1 thru 31-22	O	Jun. 1994	ADDED	5	O	Jun. 1994	REVISED
32	B	July 1987		5-1	O	Jun. 1994	ADDED
33 thru 36	O	Jun. 1994	REVISED	6	O	Jun. 1994	REVISED
36-1 thru 36-4	O	Jun. 1994	ADDED	6-1	O	Jun. 1994	ADDED
37	O	Jun. 1994	REVISED	7	I	Nov. 1990	
38	G	Nov. 1989		8	M	Nov. 1992	
38-1	C	Nov. 1987		9	E	Dec. 1988	
38-2 thru 38-4	O	Jun. 1994	REVISED	10		Nov. 1986	
39 thru 40	O	Jun. 1994	REVISED	13 - Fuel			
40-1 thru 40-2	O	Jun. 1994	ADDED	1 thru 2	O	Jun. 1994	REVISED
41 thru 44	O	Jun. 1994	REVISED	3 thru 4	J	July 1991	
44-1	O	Jun. 1994	REVISED				

LIST OF EFFECTIVE PAGES

Group/ Page	Revision code	Date	Remarks	Group/ Page	Revision code	Date	Remarks
4-1	G	Nov. 1989		64-13 thru 64-15	G	Nov. 1989	
4-2	E	Dec. 1988		64-16	N	July 1993	
4-3 thru 4-4	O	Jun. 1994	ADDED	64-17 thru 64-18	G	Nov. 1989	
5	O	Jun. 1994	REVISED	64-19	N	July 1993	
5-1 thru 5-2	O	Jun. 1994	REVISED	64-20	G	Nov. 1989	
6	O	Jun. 1994	REVISED	64-21	N	July 1993	
6-1 thru 6-2	O	Jun. 1994	ADDED	64-22	G	Nov. 1989	
7	O	Jun. 1994	REVISED	64-23	N	July 1993	
8	K	Nov. 1991		64-24	G	Nov. 1989	
8-1 thru 8-2	O	Jun. 1994	REVISED	64-25	N	July 1993	
9 thru 12		Nov. 1986		64-26	J	July 1991	
13 thru 14	G	Nov. 1989		64-27 thru 64-28	N	July 1993	
15 thru 16		Nov. 1986		64-28-1	N	July 1993	
17 thru 18	O	Jun. 1994	REVISED	64-28-2	J	July 1991	
19 thru 20	J	July 1991		64-29	G	Nov. 1989	
21		Nov. 1986		64-30 thru 64-31	N	July 1993	
22 thru 23	J	July 1991		64-31-1	N	July 1993	
24		Nov. 1986		64-31-2	J	July 1991	
25	E	Dec. 1988		64-32	J	July 1991	
26	O	Jun. 1994	REVISED	64-33 thru 64-34	N	July 1993	
26-1 thru 26-2	O	Jun. 1994	ADDED	64-34-1	J	July 1991	
27 thru 32	O	Jun. 1994	REVISED	64-34-2	N	July 1993	
32-1 thru 32-2	O	Jun. 1994	REVISED	64-34-3 thru			
33	O	Jun. 1994	REVISED	64-34-4	J	July 1991	
34 thru 36		Nov. 1986		64-35 thru 64-38	G	Nov. 1989	
37	G	Nov. 1989		64-39	N	July 1993	
38 thru 44		Nov. 1986		64-40	G	Nov. 1989	
45	F	July 1989		64-41	N	July 1993	
46	H	Jun. 1990		64-42 thru 64-43	G	Nov. 1989	
47 thru 52		Nov. 1986		64-44	N	July 1993	
53	O	Jun. 1994	REVISED	64-45 thru 64-46	G	Nov. 1989	
54 thru 56		Nov. 1986		64-47	N	July 1993	
56-1 thru 56-18	O	Jun. 1994	ADDED	64-48	J	July 1991	
57 thru 59	O	Jun. 1994	REVISED	64-49	N	July 1993	
60		Nov. 1986		64-50	G	Nov. 1989	
61 thru 63	N	July 1993		64-51	N	July 1993	
63-1	J	July 1991		64-52 thru 64-53	J	July 1991	
63-2 thru 63-3	N	July 1993		64-53-1 thru			
63-4	J	July 1991		64-53-2	J	July 1991	
64	J	July 1991		64-54	N	July 1993	
64-1	J	July 1991		64-55 thru 64-56	G	Nov. 1989	
64-2	I	Nov. 1990		64-57	N	July 1993	
64-3 thru 64-4	J	July 1991		64-58 thru 64-59	G	Nov. 1989	
64-5 thru 64-6	N	July 1993		65	B	July 1987	
64-7 thru 64-8	G	Nov. 1989		65-1	B	July 1987	
64-9 thru 64-11	J	July 1991		66 thru 71		Nov. 1986	
64-11-1 thru				72	G	Nov. 1989	
64-11-2	J	July 1991		73	O	Jun. 1994	REVISED
64-12	N	July 1993		74	J	July 1991	

LIST OF EFFECTIVE PAGES

Group/ Page	Revision code	Date	Remarks	Group/ Page	Revision code	Date	Remarks
74-1	G	Nov. 1989		2		Nov. 1986	
74-2 thru 74-3	J	July 1991		3 thru 4	O	Jun. 1994	REVISED
75	G	Nov. 1989		4-1	O	Jun. 1994	ADDED
75-1	G	Nov. 1989		5 thru 11	O	Jun. 1994	REVISED
76	J	July 1991		11-1 thru 11-4	O	Jun. 1994	ADDED
76-1 thru 76-4	G	Nov. 1989		12	O	Jun. 1994	REVISED
76-5 thru 76-68	O	Jun. 1994	ADDED	12-1	O	Jun. 1994	ADDED
77	F	July 1989		13 thru 14	O	Jun. 1994	REVISED
78 thru 79	O	Jun. 1994	REVISED	14-1	O	Jun. 1994	ADDED
80 thru 95	G	Nov. 1989		15 thru 16	O	Jun. 1994	REVISED
96	H	Jun. 1990		16-1	O	Jun. 1994	ADDED
97 thru 98	G	Nov. 1989		17 thru 18		Nov. 1986	
99 thru 100	O	Jun. 1994	REVISED	18-1	O	Jun. 1994	ADDED
100-1 thru 100-2	O	Jun. 1994	ADDED	19 thru 20	O	Jun. 1994	REVISED
101	O	Jun. 1994	REVISED	20-1	O	Jun. 1994	ADDED
101-1 thru 101-2	O	Jun. 1994	ADDED	21 thru 23		Nov. 1986	
102 thru 103	F	July 1989		24	O	Jun. 1994	REVISED
104		Nov. 1986		24-1	O	Jun. 1994	ADDED
104-1 thru 104-2	O	Jun. 1994	REVISED	25 thru 26	O	Jun. 1994	REVISED
104-3	F	July 1989		26-1	O	Jun. 1994	ADDED
104-4	O	Jun. 1994	REVISED	27	O	Jun. 1994	REVISED
104-5 thru 104-8	O	Jun. 1994	ADDED	28	H	Jun. 1990	
105 thru 107	O	Jun. 1994	REVISED				
108	B	July 1987		15 - Intake and Exhaust			
109 thru 110	N	July 1993		1	O	Jun. 1994	REVISED
111	O	Jun. 1994	REVISED	2		Nov. 1986	
111-1	O	Jun. 1994	ADDED	3	O	Jun. 1994	REVISED
112	O	Jun. 1994	REVISED	3-1	O	Jun. 1994	ADDED
112-1	O	Jun. 1994	ADDED	4	O	Jun. 1994	REVISED
113 thru 114	O	Jun. 1994	REVISED	4-1	O	Jun. 1994	ADDED
114-1	O	Jun. 1994	ADDED	5 thru 6	O	Jun. 1994	REVISED
115 thru 119	O	Jun. 1994	REVISED	7		Nov. 1986	
119-1 thru 119-3	O	Jun. 1994	ADDED	8	B	July 1987	
120 thru 121	O	Jun. 1994	REVISED	9 thru 11		Nov. 1986	
122	J	July 1991		12 thru 17	O	Jun. 1994	REVISED
122-1 thru 122-4	O	Jun. 1994	ADDED	17-1 thru 17-6	O	Jun. 1994	ADDED
123 thru 124		Nov. 1986		18 thru 21	O	Jun. 1994	REVISED
125	O	Jun. 1994	REVISED	21-1 thru 21-2	O	Jun. 1994	ADDED
125-1	O	Jun. 1994	ADDED	22	C	Nov. 1987	
126 thru 127	O	Jun. 1994	REVISED	23	E	Dec. 1988	
127-1	O	Jun. 1994	ADDED	23-1	N	July 1993	
128 thru 129		Nov. 1986		23-2	E	Dec. 188	
130 thru 132	G	Nov. 1989		23-3 thru 23-4	N	July 1993	
133 thru 134		Nov. 1986		24	O	Jun. 1994	REVISED
135 thru 136	G	Nov. 1989		24-1	O	Jun. 1994	ADDED
137		Nov. 1986		25	O	Jun. 1994	REVISED
				25-1 thru 25-2	O	Jun. 1994	REVISED
14 - Cooling				25-3 thru 25-4	O	Jun. 1994	ADDED
1	O	Jun. 1994	REVISED	26	O	Jun. 1994	REVISED

Group/ Page	Revision code	Date	Remarks	Group/ Page	Revision code	Date	Remarks
16 - Engine Electrical				18 thru 21	J	July 1991	
1 thru 2	O	Jun. 1994	REVISED	22		Nov. 1986	
2-1 thru 2-2	O	Jun. 1994	ADDED	22-1 thru 22-14	O	Jun. 1994	ADDED
3	O	Jun. 1994	REVISED	23	O	Jun. 1994	REVISED
4 thru 8	N	July 1993		24 thru 28		Nov. 1986	
9	O	Jun. 1994	REVISED	29	F	July 1989	
9-1 thru 9-2	O	Jun. 1994	ADDED	30 thru 32		Nov. 1986	
10 thru 11	O	Jun. 1994	REVISED	33	F	July 1989	
11-1	O	Jun. 1994	REVISED	34 thru 35		Nov. 1986	
11-2	J	July 1991		35-1 thru 35-12	O	Jun. 1994	ADDED
12 thru 14	O	Jun. 1994	REVISED	36	O	Jun. 1994	REVISED
15		Nov. 1986		37 thru 38		Nov. 1986	
16	O	Jun. 1994	REVISED	39	G	Nov. 1989	
17		Nov. 1986		40	E	Dec. 1988	
17-1 thru 17-2	O	Jun. 1994	ADDED	40-1 thru 40-2	J	July 1991	
18	N	July 1993		41	G	Nov. 1989	
19	O	Jun. 1994	REVISED	42	J	July 1991	
19-1	O	Jun. 1994	REVISED	43		Nov. 1986	
19-2	N	July 1993		44 thru 46	J	July 1991	
20		Nov. 1986		47	G	Nov. 1989	
21	N	July 1993		48	F	July 1989	
21-1	O	Jun. 1994	REVISED	48-1 thru 48-6	O	Jun. 1994	REVISED
21-2	N	July 1993		48-7 thru 48-16	O	Jun. 1994	ADDED
22	N	July 1993		49	O	Jun. 1994	REVISED
23		Nov. 1986		21 - Clutch			
24	F	July 1989		1		Nov. 1986	
24-1 thru 24-2	N	July 1993		2	E	Dec. 1988	
25	N	July 1993		3	F	July 1989	
17 - Emission Control				4	I	Nov. 1990	
1 thru 2	O	Jun. 1994	REVISED	5		Nov. 1986	
2	E	Dec. 1988		6	C	Nov. 1987	
3		Nov. 1986		7	I	Nov. 1990	
4	J	July 1991		8	B	July 1987	
4-1 thru 4-2	O	Jun. 1994	REVISED	9		Nov. 1986	
4-3 thru 4-6	O	Jun. 1994	ADDED	10 thru 11	E	Dec. 1988	
5	O	Jun. 1994	REVISED	12 thru 13		Nov. 1986	
5-1 thru 5-2	O	Jun. 1994	REVISED	14 thru 15	I	Nov. 1990	
6 thru 8	O	Jun. 1994	REVISED	16		Nov. 1986	
9		Nov. 1986		17	H	Jun. 1990	
9-1 thru 9-2	J	July 1991		22 - Manual Transmission			
10	H	Jun. 1990		1		Nov. 1986	
10-1 thru 10-2	H	Jun. 1990		2	O	Jun. 1994	REVISED
11		Nov. 1986		3	N	July 1993	
12	H	Jun. 1990		4	B	July 1987	
12-1 thru 12-2	J	July 1991		5		Nov. 1986	
13		Nov. 1986		6	N	July 1993	
14 thru 16	J	July 1991		7		Nov. 1986	
17		Nov. 1986					

LIST OF EFFECTIVE PAGES

Group/ Page	Revision code	Date	Remarks	Group/ Page	Revision code	Date	Remarks
8 thru 9	H	Jun. 1990		24 thru 25	E	Dec. 1988	
10		Nov. 1986		26 thru 27		Nov. 1986	
11	H	Jun. 1990		28	E	Dec. 1988	
12 thru 18		Nov. 1986		29 thru 30	H	Jun. 1990	
19	O	Jun. 1994	REVISED	31 thru 37		Nov. 1986	
19-1 thru 19-2	O	Jun. 1994	ADDED	38 thru 39	H	Jun. 1990	
20 thru 21		Nov. 1986		40 thru 48		Nov. 1986	
22	C	Nov. 1987		49	E	Dec. 1988	
22-1 thru 22-2	B	July 1987		50		Nov. 1986	
23		Nov. 1986		51 thru 52	B	July 1987	
				53		Nov. 1986	
23 - Automatic Transmission				54 thru 56	B	July 1987	
1	H	Jun. 1990		57 thru 58		Nov. 1986	
2	G	Nov. 1989		59	E	Dec. 1988	
3	H	Jun. 1990		60 thru 66		Nov. 1986	
4	O	Jun. 1994	REVISED	67	E	Dec. 1988	
5		Nov. 1986		68 thru 69		Nov. 1986	
6 thru 7	O	Jun. 1994	REVISED	70	E	Dec. 1988	
8 thru 13		Nov. 1986		71		Nov. 1986	
14	H	Jun. 1990		72 thru 73	E	Dec. 1988	
15 thru 16	O	Jun. 1994	REVISED	74		Nov. 1986	
16		Nov. 1986		75	H	Jun. 1990	
17	H	Jun. 1990		76		Nov. 1986	
18 thru 21		Nov. 1986		77	H	Jun. 1990	
22 thru 23	O	Jun. 1994	REVISED	78	E	Dec. 1988	
24		Nov. 1986		79 thru 80		Nov. 1986	
25	O	Jun. 1994	REVISED	81	E	Dec. 1988	
25-1 thru 25-2	O	Jun. 1994	ADDED	82	B	July 1987	
26 thru 27		Nov. 1986		83 thru 84	E	Dec. 1988	
				85	H	Jun. 1990	
25 - Propeller Shaft				86		Nov. 1986	
1		Nov. 1986		87	H	Jun. 1990	
2 thru 3	O	Jun. 1994	REVISED	88		Nov. 1986	
3-1	O	Jun. 1994	ADDED	89	G	Nov. 1989	
4	O	Jun. 1994	REVISED	90		Nov. 1986	
4-1	O	Jun. 1994	ADDED	91	H	Jun. 1990	
5	F	July 1989					
6	B	July 1987		27 - Rear Axle			
7 thru 9	F	July 1989		1	O	Jun. 1994	REVISED
10		Nov. 1986		2		Nov. 1986	
				3	G	Nov. 1989	
26 - Front Axle				4	O	Jun. 1994	REVISED
1 thru 13		Nov. 1986		5	B	July 1987	
14	K	Nov. 1991		6 thru 7	O	Jun. 1994	REVISED
15	E	Dec. 1988		7-1 thru 7-2	O	Jun. 1994	ADDED
16	H	Jun. 1990		8 thru 9	O	Jun. 1994	REVISED
17 thru 21		Nov. 1986		9-1 thru 9-2	O	Jun. 1994	ADDED
22	C	Nov. 1987		10		Nov. 1986	
23		Nov. 1986		11	B	July 1987	

LIST OF EFFECTIVE PAGES

Group/ Page	Revision code	Date	Remarks	Group/ Page	Revision code	Date	Remarks
33	O	Jun. 1994	REVISED	34	D	July 1988	
34 thru 35		Nov. 1986		35	I	Nov. 1990	
				36		Nov. 1986	
34 - Rear Suspension				37	N	July 1993	
1 thru 2		Nov. 1986		38		Nov. 1986	
3	C	Nov. 1987		39	N	July 1993	
4		Nov. 1986		40		Nov. 1986	
4-1	K	Nov. 1991		41	H	Jun. 1990	
4-2	C	Nov. 1987		42 thru 45		Nov. 1986	
5	D	July 1988		46	H	Jun. 1990	
6		Nov. 1986		47 thru 48		Nov. 1986	
7 thru 8	C	Nov. 1987		49 thru 50	B	July 1987	
8-1 thru 8-2	E	Dec. 1988		51		Nov. 1986	
9 thru 11		Nov. 1986		52	B	July 1987	
12	K	Nov. 1991		53		Nov. 1986	
13		Nov. 1986		54	B	July 1987	
				54-1 thru 54-2	E	Dec. 1988	
35 - Service Brakes				54-3 thru 54-8	B	July 1987	
1	D	July 1988		55 thru 60		Nov. 1986	
2 thru 3		Nov. 1986		61	D	July 1988	
4	C	Nov. 1987		62		Nov. 1986	
4-1	K	Nov. 1991		63	H	Jun. 1990	
4-2	E	Dec. 1988		64		Nov. 1986	
5	C	Nov. 1987		65	D	July 1988	
5-1 thru 5-2	O	Jun. 1994	REVISED	66	I	Nov. 1990	
6	K	Nov. 1991		67	D	July 1988	
7 thru 8	N	July 1993		68 thru 69		Nov. 1986	
9	B	July 1987		70 thru 71	I	Nov. 1990	
10 thru 11		Nov. 1986		72 thru 73		Nov. 1986	
12 thru 13	F	July 1989		74	H	Jun. 1990	
14	D	July 1988		75 thru 76		Nov. 1986	
15	E	Dec. 1988		77	H	Jun. 1990	
16	D	July 1988		78 thru 80		Nov. 1986	
17		Nov. 1986		81	H	Jun. 1990	
18 thru 19	K	Nov. 1991		82		Nov. 1986	
20	I	Nov. 1990		83	H	Jun. 1990	
21 thru 22	L	July 1992		84	E	Dec. 1988	
22-1 thru 22-4	L	July 1992		85	I	Nov. 1990	
23		Nov. 1986					
24	B	July 1987		36 - Parking Brakes			
25	E	Dec. 1988		1 thru 2		Nov. 1986	
26		Nov. 1986		3	D	July 1988	
27	F	July 1989		4 thru 5	B	July 1987	
28		Nov. 1986		6 thru 8		Nov. 1986	
29	F	July 1989		9	D	July 1988	
30		Nov. 1986		10 thru 15		Nov. 1986	
31	D	July 1988					
32		Nov. 1986		37 - Steering			
33	E	Dec. 1988		1	F	July 1989	

LIST OF EFFECTIVE PAGES

Group/ Page	Revision code	Date	Remarks	Group/ Page	Revision code	Date	Remarks
2 thru 3		Nov. 1986		30		Nov. 1986	
4 thru 5	E	Dec. 1988		31	H	Jun. 1990	
6 thru 7	O	Jun. 1994	REVISED	32		Nov. 1986	
8	H	Jun. 1990		33	H	Jun. 1990	
9	C	Nov. 1987		34 thru 40		Nov. 1986	
10	E	Dec. 1988		41 thru 42	E	Dec. 1988	
11 thru 16		Nov. 1986		43 thru 44		Nov. 1986	
17 thru 22	F	July 1989		45 thru 47	K	Nov. 1991	
23 thru 26		Nov. 1986		48		Nov. 1986	
27	D	July 1988		49	H	Jun. 1990	
28		Nov. 1986		50	K	Nov. 1991	
29	H	Jun. 1990		51	L	July 1992	
30 thru 32		Nov. 1986		52 thru 54		Nov. 1986	
33 thru 35	H	Jun. 1990		55	H	Jun. 1990	
36	F	July 1989		56	G	Nov. 1989	
37 thru 38	E	Dec. 1988		57	H	Jun. 1990	
39		Nov. 1986		58	G	Nov. 1989	
40 thru 41	H	Jun. 1990		59	F	July 1989	
42	F	July 1989		60 thru 61	I	Nov. 1990	
43		Nov. 1986		61-1	I	Nov. 1990	
44	G	Nov. 1989		61-2	D	July 1988	
45		Nov. 1986		62	H	Jun. 1990	
46	F	July 1989		63 thru 66	B	July 1987	
47 thru 48		Nov. 1986		67	E	Dec. 1988	
49 thru 50	F	July 1989		68	H	Jun. 1990	
51 thru 53	H	Jun. 1990		68-1	H	Jun. 1990	
54	O	Jun. 1994	REVISED	68-2 thru 68-5	B	July 1987	
54-1 thru 54-2	O	Jun. 1994	ADDED	68-6	D	July 1988	
55 thru 56	O	Jun. 1994	REVISED	68-7 thru 68-10	L	July 1992	
57 thru 59	F	July 1989		69 thru 70		Nov. 1986	
59-1 thru 59-4	O	Jun. 1994	ADDED	71	H	Jun. 1990	
60 thru 61	O	Jun. 1994	REVISED	72		Nov. 1986	
62		Nov. 1986		73 thru 83	1	Jan. 1987	
42 - Body				83-1	B	July 1987	
1	D	July 1988		83-2 thru 83-5	C	Nov. 1987	
2	B	July 1987		83-6	J	July 1991	
3		Nov. 1986		83-7	F	July 1989	
4	H	Jun. 1990		83-8	H	Jun. 1990	
5 thru 7		Nov. 1986		83-9	L	July 1992	
8	C	Nov. 1987		83-10	J	July 1991	
9	B	July 1987		83-11 thru 83-12	K	Nov. 1991	
10 thru 13		Nov. 1986		83-13 thru 83-15	L	July 1992	
14 thru 21	H	Jun. 1990		84	1	Jan. 1987	
22		Nov. 1986		84-1	1	Jan. 1987	
23	H	Jun. 1990		85 thru 88	1	Jan. 1987	
24 thru 26		Nov. 1986		89	H	Jun. 1990	
27	F	July 1989		90 thru 95	1	Jan. 1987	
28 thru 29	K	Nov. 1991		95-1	B	July 1987	
				96 thru 98	1	Jan. 1987	

LIST OF EFFECTIVE PAGES

Group/ Page	Revision code	Date	Remarks	Group/ Page	Revision code	Date	Remarks
98-1	D	July 1988		185	1	Jan. 1987	
99 thru 100	1	Jan. 1987		186	H	Jun. 1990	
101	F	July 1989		187	1	Jan. 1987	
102 thru 103	1	Jan. 1987		188	H	Jun. 1990	
104 thru 105	H	Jun. 1990		189	1	Jan. 1987	
106 thru 112	1	Jan. 1987		190	H	Jun. 1990	
113	F	July 1989		191 thru 209	1	Jan. 1987	
114 thru 118	1	Jan. 1987		210 thru 211	C	Nov. 1987	
118-1 thru 118-6	F	July 1989		212 thru 221	1	Jan. 1987	
118-7 thru 118-10	K	Nov. 1991		221-1 thru 221-2	B	July 1987	
119 thru 120	B	July 1987		222 thru 223	1	Jan. 1987	
121	1	Jan. 1987		224 thru 228	C	Nov. 1987	
122	F	July 1989		229	1	Jan. 1987	
123	L	July 1992		230	C	Nov. 1987	
123-1 thru 123-2	K	Nov. 1991		231	1	Jan. 1987	
124	F	July 1989		232 thru 235	C	Nov. 1987	
125	D	July 1988		236 thru 254	1	Jan. 1987	
126 thru 127	H	Jun. 1990		255 thru 256	D	July 1988	
127-1 thru 127-2	B	July 1987		257 thru 259	1	Jan. 1987	
128 thru 132	1	Jan. 1987		260 thru 261	B	July 1987	
133	E	Dec. 1988		262 thru 263	1	Jan. 1987	
133-1 thru 133-2	E	Dec. 1988		264 thru 275	B	July 1987	
134 thru 135	E	Dec. 1988		276 thru 283	1	Jan. 1987	
135-1 thru 135-2	J	July 1991		284	F	July 1989	
136 thru 141	1	Jan. 1987		285	1	Jan. 1987	
142	K	Nov. 1991		286 thru 287	I	Nov. 1990	
143	1	Jan. 1987		288 thru 289	1	Jan. 1987	
143-1 thru 143-2	K	Nov. 1991		289-1 thru 289-2	C	Nov. 1987	
144 thru 151	1	Jan. 1987		289-3 thru 289-4	H	Jun. 1990	
152	K	Nov. 1991		290 thru 292	F	July 1989	
153	1	Jan. 1987		293	D	July 1988	
154	K	Nov. 1991		293-1	G	Nov. 1989	
155	1	Jan. 1987		293-2	E	Dec. 1988	
155-1 thru 155-4	K	Nov. 1991		293-3	H	Jun. 1990	
156 thru 159	1	Jan. 1987		293-4	F	July 1989	
160	K	Nov. 1991		293-5	I	Nov. 1990	
161	1	Jan. 1987		293-6	G	Nov. 1989	
161-1 thru 161-2	K	Nov. 1991		293-7	J	July 1991	
162	H	Jun. 1990		293-8	H	Jun. 1990	
163 thru 177	1	Jan. 1987		293-9	K	Nov. 1991	
178	I	Nov. 1990		293-10	I	Nov. 1990	
179	1	Jan. 1987		293-11	L	July 1992	
179-1	I	Nov. 1990		293-12	K	Nov. 1991	
179-2	H	Jun. 1990		293-13	M	Nov. 1992	
180	H	Jun. 1990		293-14	K	Nov. 1991	
181	1	Jan. 1987		293-15	N	July 1993	
182	H	Jun. 1990		293-16	L	July 1992	
183	1	Jan. 1987					
184	H	Jun. 1990					
				293-17 thru			
				293-18	O	Jun. 1994	REVISED

LIST OF EFFECTIVE PAGES

Group/ Page	Revision code	Date	Remarks	Group/ Page	Revision code	Date	Remarks
294	N	July 1993		12	B	July 1987	
294-1 thru 294-2	N	July 1993		13		Nov. 1986	
295	K	Nov. 1991		14	B	July 1987	
296 thru 297	I	Nov. 1990		15	O	Jun. 1994	REVISED
298 thru 301	1	Jan. 1987		16		Nov. 1986	
Appendices				17 thru 18	B	July 1987	
1 thru 7	1	Jan. 1987		19		Nov. 1986	
7-1	B	July 1987		20	B	July 1987	
8	1	Jan. 1987		21		Nov. 1986	
9 thru 10	C	Nov. 1987		22	B	July 1987	
51 - Exterior				23		Nov. 1986	
1	I	Nov. 1990		23-1 thru 23-2	E	Dec. 1988	
2		Nov. 1986		24 thru 32		Nov. 1986	
3	H	Jun. 1990		33	B	July 1987	
4	I	Nov. 1990		34		Nov. 1986	
5	H	Jun. 1990		35 thru 37	B	July 1987	
6	I	Nov. 1990		37-1	H	Jun. 1990	
6-1 thru 6-2	I	Nov. 1990		37-2	B	July 1987	
7	H	Jun. 1990		38	B	July 1987	
8 thru 11		Nov. 1986		39		Nov. 1986	
12 thru 13	H	Jun. 1990		40 thru 41	B	July 1987	
14 thru 17		Nov. 1986		42		Nov. 1986	
18	B	July 1987		43 thru 45	B	July 1987	
18-1 thru 18-2	D	July 1988		45-1 thru 45-2	J	July 1991	
19		Nov. 1986		46	B	July 1987	
20	B	July 1987		47		Nov. 1986	
21 thru 26		Nov. 1986		48	B	July 1987	
27	G	Nov. 1989		54 - Chassis Electrical			
28	D	July 1988		1	L	July 1992	
29	B	July 1987		2	J	July 1991	
30	D	July 1988		2-1 thru 2-2	J	July 1991	
31	G	Nov. 1989		3	B	July 1987	
32	B	July 1987		4		Nov. 1986	
33		Nov. 1986		5	D	July 1988	
34	D	July 1988		6	I	Nov. 1990	
35 thru 36	I	Nov. 1990		7	N	July 1993	
36-1 thru 36-2	I	Nov. 1990		8 thru 10	I	Nov. 1990	
52 - Interior				11	N	July 1993	
1	B	July 1987		12 thru 13		Nov. 1986	
2		Nov. 1986		14	G	Nov. 1989	
3	H	Jun. 1990		15 thru 17	E	Dec. 1988	
4 thru 6		Nov. 1986		18 thru 19	B	July 1987	
7	J	July 1991		20		Nov. 1986	
8		Nov. 1986		21	H	Jun. 1990	
9 thru 10	J	July 1991		22		Nov. 1986	
11		Nov. 1986		23 thru 24	H	Jun. 1990	
				24-1 thru 24-2	O	Jun. 1994	ADDED
				25 thru 27		Nov. 1986	

LIST OF EFFECTIVE PAGES

Group/ Page	Revision code	Date	Remarks	Group/ Page	Revision code	Date	Remarks
27-1 thru 27-4	J	July 1991		46	K	Nov. 1991	
28	I	Nov. 1990		47 thru 49	B	July 1987	
29	M	Nov. 1992		50 thru 51	N	July 1993	
30 thru 31	H	Jun. 1990		52	B	July 1987	
31-1 thru 31-2	H	Jun. 1990		52-1 thru 52-2	I	Nov. 1990	
32	H	Jun. 1990		53 thru 63	N	July 1993	
32-1 thru 32-2	I	Nov. 1990		64	I	Nov. 1990	
33	I	Nov. 1990		64-1	N	July 1993	
34 thru 35		Nov. 1986		64-2	I	Nov. 1990	
36	D	July 1988		65 thru 66	I	Nov. 1990	
37 thru 38		Nov. 1986		67	N	July 1993	
38-1 thru 38-2	B	July 1987		67-1 thru 67-4	N	July 1993	
39 thru 41		Nov. 1986		68	N	July 1993	
42	B	July 1987		68-1 thru 68-2	N	July 1993	
43	D	July 1988		69 thru 71	I	Nov. 1990	
44		Nov. 1986		72 thru 74	B	July 1987	
45	B	July 1987		75 thru 76	N	July 1993	
46 thru 48		Nov. 1986		76-1 thru 76-2	N	July 1993	
49	H	Jun. 1990		77 thru 80	N	July 1993	
49-1 thru 49-2	H	Jun. 1990		81 thru 83	O	Jun. 1994	
50 thru 51	H	Jun. 1990		84 thru 85	B	July 1987	
51-1 thru 51-2	H	Jun. 1990		86	N	July 1993	
52 thru 53		Nov. 1986		86-1 thru 86-2	N	July 1993	
54	B	July 1987		87 thru 88	B	July 1987	
55	H	Jun. 1990		89	N	July 1993	
55-1 thru 55-2	H	Jun. 1990		90	B	July 1987	
56 thru 59		Nov. 1986		91	N	July 1993	
60	D	July 1988		92	B	July 1987	
61 thru 63		Nov. 1986		93 thru 95	N	July 1993	
64	K	Nov. 1991					
65	L	July 1992					

55 - Heater, Air Conditioner and Ventilation

1	N	July 1993	
2 thru 3	B	July 1987	
4	D	July 1988	
5 thru 6	C	Nov. 1987	
7	D	July 1988	
8 thru 10	B	July 1987	
11 thru 12	C	Nov. 1987	
13 thru 15		Nov. 1986	
16	E	Dec. 1988	
17 thru 20	C	Nov. 1987	
21 thru 34		Nov. 1986	
35 thru 37	B	July 1987	
38	E	Dec. 1988	
39 thru 42	B	July 1987	
43	K	Nov. 1991	
44 thru 45	B	July 1987	

Wiring Diagram

For Europe		Nov. 1986	
For General		Nov. 1986	
Export and Australia			
Air Conditioner	D	July 1988	
Roof blind	D	July 1988	
Remote control mirror	D	July 1988	
For Europe (1990 model)	G	Nov. 1989	

RJST409012-634
RJST307015-182
RJST211015-66
RJST207015-78
RJST111014-122
RJST108015-260
RJYM011014-468
RJYM007009-478
RJYM911007-374
RJYM907008-464
RJAK811014-420
RJYM808005-380
RJYM711012-520
RJYM707010-415
RJYM611016-1182

MITSUBISHI L300

WORKSHOP MANUAL

FOREWORD

This Workshop Manual contains procedures for removal, disassembly, inspection, adjustment, reassembly and installation, etc. for service mechanics. Use the following manuals in combination with this manual required.

WORKSHOP MANUAL	PWEE□□□□
ENGINE GROUP	(Looseleaf edition)
WIRING HARNESS	PHWE8604□
	PHWE8907□
	PHWE9022□
PARTS CATALOGUE	B603180□A□
	B803180□A□
	BFA3180□A□

All information, illustrations and product descriptions contained in this manual are current as at the time of publication. We, however, reserve the right to make changes at any time without prior notice or obligation.

General	01
Engine	11
Lubrication	12
Fuel	13
Cooling	14
Intake and Exhaust	15
Engine Electrical	16
Emission Control	17
Clutch	21
Manual Transmission	22
Automatic Transmission	23
Propeller Shaft	25
Front Axle	26
Rear Axle	27
Wheel and Tyre	31
Power Plant Mount	32
Front Suspension	33
Rear Suspension	34
Service Brakes	35
Parking Brakes	36
Steering	37
Body	42
Exterior	51
Interior	52
Chassis Electrical	54
Heater, Air Conditioner and Ventilation	55
Wiring Diagram	



HOW TO USE THIS MANUAL

E01BAANa

CONTENTS

The preceding page contains the GROUP INDEX which lists the group title and group number.

PAGE NUMBERS

All page numbers consist of two sets of digits separated by a dash. The digits preceding the dash identify the number of the group. The digits following the dash represent the consecutive page number within the group. The page numbers can be found on the top left or right of each page.

TEXT

Unless otherwise specified, each service procedure covers all models. Procedures covering specific models are identified by the model codes, destination or similar designation (engine type, transmission type, etc.). A description of these designations is covered in GROUP 01 under "VEHICLE IDENTIFICATION".

SERVICE PROCEDURES

The service steps are arranged in numerical order and attentions to be paid in performing vehicle service are described in detail in SERVICE POINTS.

INDICATION OF DESTINATION

Europe, General Export and Australia used for convenience to indicate destination.

NOTE

1. "General Export" means territories other than Europe, Australia, the U.S.A. and Canada.
2. GCC indicates a classification within the models for General Export category; models for countries that are members of the (Persian) Gulf Cooperation Council of nations.
3. Shipments are made to some countries of vehicles made to the specifications of a third country.

DEFINITION OF TERMS

STANDARD VALUE

Indicates the value used as the standard for judging the quality of a part or assembly on inspection or the value to which the part or assembly is corrected and adjusted. It is given by tolerance.

LIMIT

Shows the standard for judging the quality of a part or assembly on inspection and means the maximum or minimum value within which the part or assembly must be kept functionally or in strength. It is a value established outside the range of standard value.

Removal steps:

The part designation number corresponds to the number in the illustration to indicate removal steps.

Disassembly steps:

The part designation number corresponds to the number in the illustration to indicate disassembly steps.

Installation steps:

Specified in case installation is impossible in reverse order of removal steps. Omitted if installation is possible in reverse order of removal steps.

Reassembly steps:





Specified in case reassembly is impossible in reverse order of disassembly steps. Omitted if reassembly is possible in reverse order of disassembly steps.

Denotes service point classification.

- ◄◄ : Removal
- : Installation
- ◄► : Disassembly
- ◄ : Reassembly

Symbols for Lubrication, Sealants and Adhesives

Information concerning the locations for lubrication and for application of sealants and adhesives is provided, by using symbols, in the diagram of component parts or on the page following the component parts or on the page following the component parts page, and explained.

-  : Grease (multipurpose grease unless there is a brand or type specified)
-  : Sealant or adhesive
-  : Brake fluid or automatic transmission fluid
-  : Engine oil or gear oil
-  : Adhesive tape or butyl rubber tape

Indicates vehicles made to specifications for Europe. Also applies to vehicles shipped to general export countries but made to specifications for Europe.

Page number

Group title

Section title

27-20

REAR AXLE - Axle Shaft (2WD)

AXLE SHAFT (2WD) - Vehicles for Europe

EZ7MA--

REMOVAL AND INSTALLATION

Post-installation Operation

- Air bleeding of brake line (Refer to GROUP 35 SERVICE BRAKES - Service Adjustment Procedures.)
- Adjustment of parking brake pull rod (Refer to GROUP 36 PARKING BRAKES - Service Adjustment Procedures.)

Denotes tightening torque

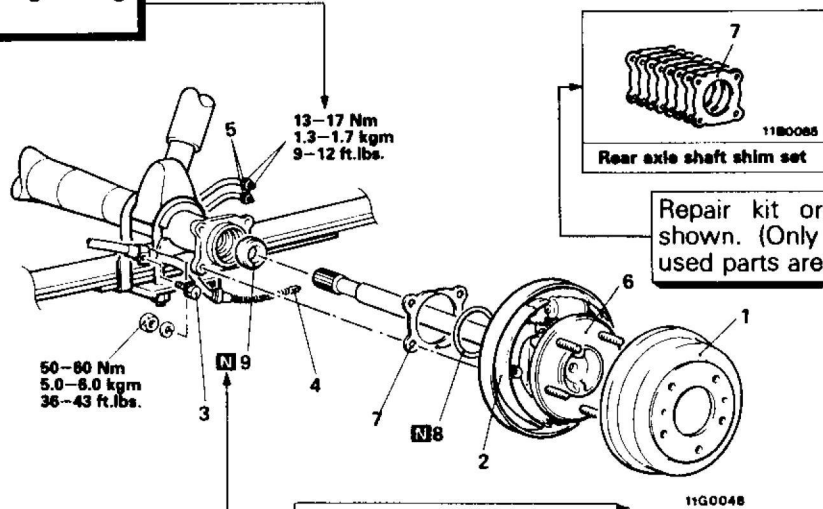

Repair kit or set parts are shown. (Only very frequently used parts are shown.)

Denotes non-reusable part

Removal steps

1. Brake drum
2. Shoe and lining assembly
3. Bolt
4. Parking brake cable connection
5. Brake tubes connections
6. Axle shaft assembly
7. Shim
8. O-ring
9. Adjustment of axle shaft axial play
- Oil seal

This number corresponds to the number appearing in "Removal steps", "Disassembly steps", "Installation steps" or "Reassembly steps".

NOTE

- (1) Reverse the removal procedures to reinstall.
- (2) ♦♦ : Refer to "Service Points of Removal".
- (3) ♦♦♦ : Refer to "Service Points of Installation".
- (4) N : Non-reusable parts

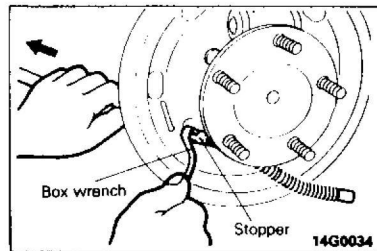

© Mitsubishi Motors Corporation NOV. 86

SERVICE POINTS OF REMOVAL

EZ7MA-B

2. **REMOVAL OF SHOE AND LINING ASSEMBLY**
Refer to GROUP 35 SERVICE BRAKES - Rear Brake Shoe.
4. **DISCONNECTION OF PARKING BRAKE CABLE**
Remove parking brake cable from the backing plate by pushing the parking brake cable with a box wrench to the position of the stopper.
5. **DISCONNECTION OF BRAKE TUBES**
Before disconnecting the brake tube, drain the brake fluid from the bleeder screw at the right side of the rear brake.

PWWE8608

Operating procedures, cautions, etc. on removal, installation, disassembly and reassembly are described.

